

## Super FAP-G Series

## N-CHANNEL SILICON POWER MOSFET

### Features

- High speed switching
- No secondary breakdown
- Avalanche-proof
- Low on-resistance
- Low driving power

### Applications

- Switching regulators
- UPS (Uninterruptible Power Supply)
- DC-DC converters

### Maximum ratings and characteristic Absolute maximum ratings (Tc=25°C unless otherwise specified)

Item	Symbol	Ratings	Unit	Remarks
Drain-source voltage	V <sub>DS</sub>	500	V	
	V <sub>DSX</sub>	500	V	V <sub>GS</sub> =-30V
Continuous drain current	I <sub>D</sub>	3.6	A	
Pulsed drain current	I <sub>D(puls)</sub>	±14.4	A	
Gate-source voltage	V <sub>GS</sub>	±30	V	
Repetitive or non-repetitive	I <sub>AR</sub>	3.6	A	Note *1
Non-repetitive Maximum avalanche energy	E <sub>AS</sub>	227.9	mJ	Note *2
Repetitive Maximum avalanche energy	E <sub>AR</sub>	6.0	mJ	Note *3
Maximum drain-source dV/dt	dV <sub>DS</sub> /dt	20	kV/μs	V <sub>DS</sub> ≤ 500V
Peak diode recovery dV/dt	dV/dt	5	kV/μs	Note *4
Maximum power dissipation	P <sub>D</sub>	60	W	T <sub>c</sub> =25°C
		2.02	W	T <sub>a</sub> =25°C
Operating and storage temperature range	T <sub>ch</sub> T <sub>stg</sub>	+150 -55 to +150	°C	

Note \*1 T<sub>ch</sub> ≤ 150°C

Note \*2 Starting T<sub>ch</sub>=25°C, I<sub>AS</sub>=1.5A, L=186mH, V<sub>CC</sub>=50V, R<sub>G</sub>=50Ω  
E<sub>AS</sub> limited by maximum channel temperature and avalanche current.  
See to 'Avalanche Energy' graph.

Note \*3 Repetitive rating : Pulse width limited by maximum channel temperature.  
See to 'Transient Thermal impedance' graph.

Note \*4 I<sub>F</sub> ≤ -I<sub>D</sub>, -di/dt=50A/μs, V<sub>CC</sub> ≤ BV<sub>DSS</sub>, T<sub>ch</sub> ≤ 150°C

### Outline Drawings [mm]

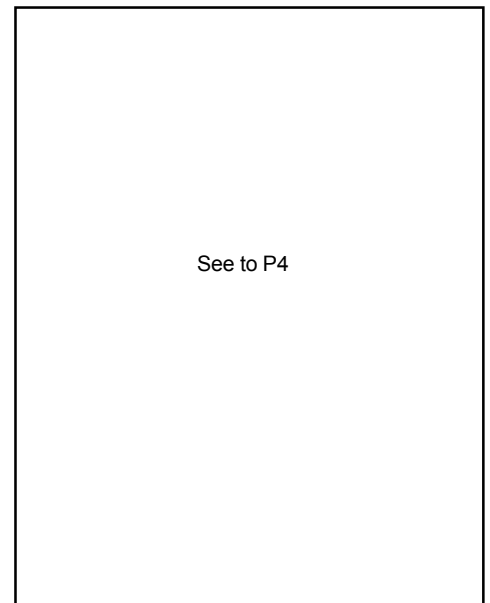

### Equivalent circuit schematic

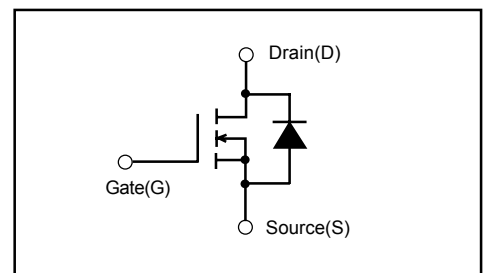

### Electrical characteristics (T<sub>c</sub> =25°C unless otherwise specified)

Item	Symbol	Test Conditions	Min.	Typ.	Max.	Units
Drain-source breakdown voltage	BV <sub>DSS</sub>	I <sub>D</sub> = 250μA V <sub>GS</sub> =0V	500			V
Gate threshold voltage	V <sub>GS(th)</sub>	I <sub>D</sub> = 250μA V <sub>DS</sub> =V <sub>GS</sub>	3.0		5.0	V
Zero gate voltage drain current	I <sub>DSS</sub>	V <sub>DS</sub> =500V V <sub>GS</sub> =0V T <sub>ch</sub> =25°C			25	μA
		V <sub>DS</sub> =400V V <sub>GS</sub> =0V T <sub>ch</sub> =125°C			250	
Gate-source leakage current	I <sub>GSS</sub>	V <sub>GS</sub> =±30V V <sub>DS</sub> =0V			100	nA
Drain-source on-state resistance	R <sub>DS(on)</sub>	I <sub>D</sub> =1.8A V <sub>GS</sub> =10V		1.84	2.3	Ω
Forward transconductance	g <sub>fs</sub>	I <sub>D</sub> =1.8A V <sub>DS</sub> =25V	1.7	3.4		S
Input capacitance	C <sub>iss</sub>	V <sub>DS</sub> =25V		330	500	pF
Output capacitance	C <sub>oss</sub>	V <sub>GS</sub> =0V		50	75	
Reverse transfer capacitance	C <sub>rss</sub>	f=1MHz		2.5	5.0	
Turn-on time t <sub>on</sub>	td(on)	V <sub>CC</sub> =300V I <sub>D</sub> =1.8A		11	18	ns
	t <sub>r</sub>	V <sub>GS</sub> =10V		5.0	7.5	
Turn-off time t <sub>off</sub>	td(off)	R <sub>GS</sub> =10 Ω		23	35	
	t <sub>r</sub>			6.0	9.0	
Total Gate Charge	Q <sub>G</sub>	V <sub>CC</sub> =250V		13	20	nC
Gate-Source Charge	Q <sub>GS</sub>	I <sub>D</sub> =3.6A		5.5	8.5	
Gate-Drain Charge	Q <sub>GD</sub>	V <sub>GS</sub> =10V		2.5	3.8	
Diode forward on-voltage	V <sub>SD</sub>	I <sub>F</sub> =3.6A V <sub>GS</sub> =0V T <sub>ch</sub> =25°C		1.00	1.50	V
Reverse recovery time	t <sub>rr</sub>	I <sub>F</sub> =3.6A V <sub>GS</sub> =0V		0.5		μs
Reverse recovery charge	Q <sub>rr</sub>	-di/dt=100A/μs T <sub>ch</sub> =25°C		2.3		μC

### Thermal characteristics

Item	Symbol	Test Conditions	Min.	Typ.	Max.	Units
Thermal resistance	R <sub>th(ch-c)</sub>	channel to case			2.083	°C/W
	R <sub>th(ch-a)</sub>	channel to ambient			62.0	°C/W

Characteristics

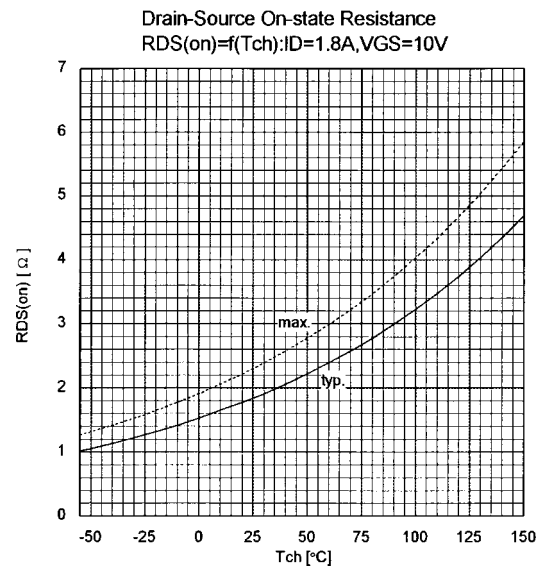
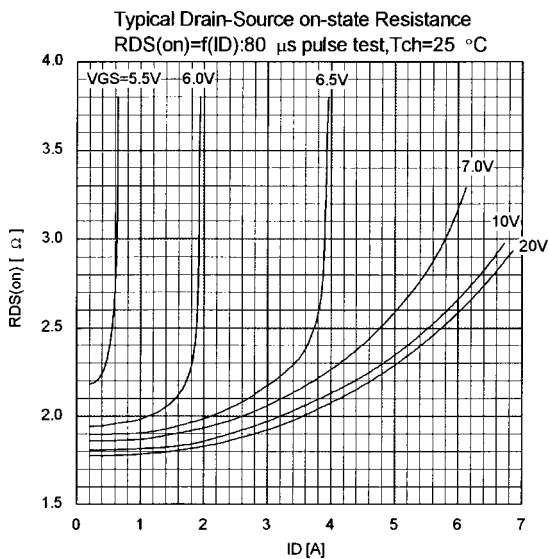
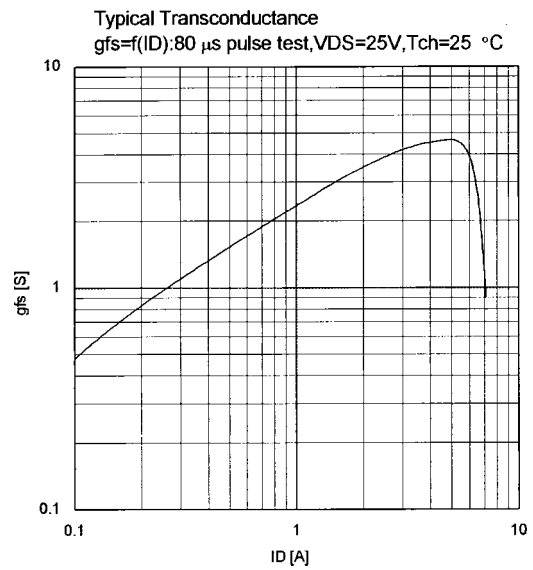
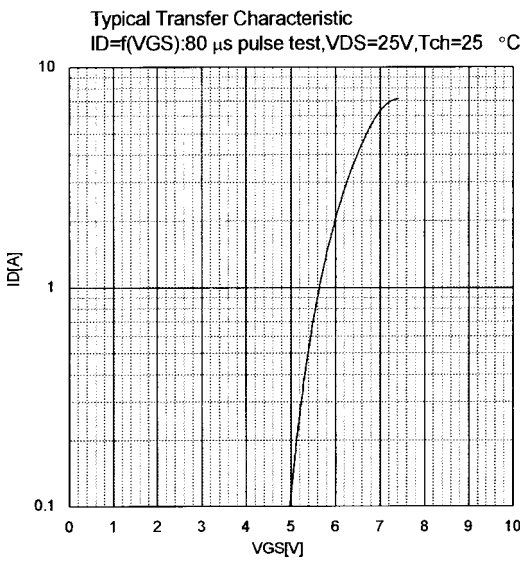
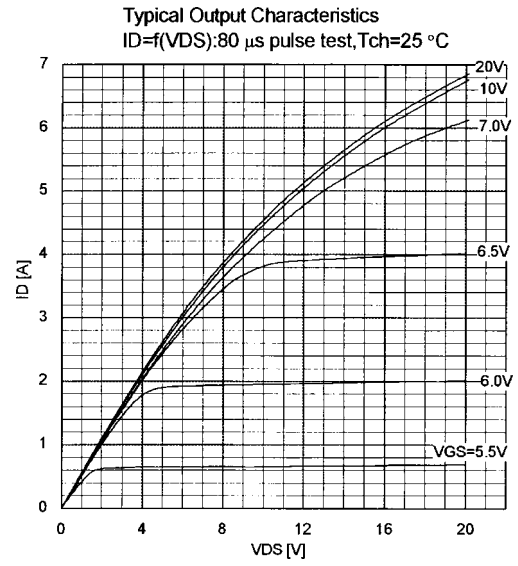
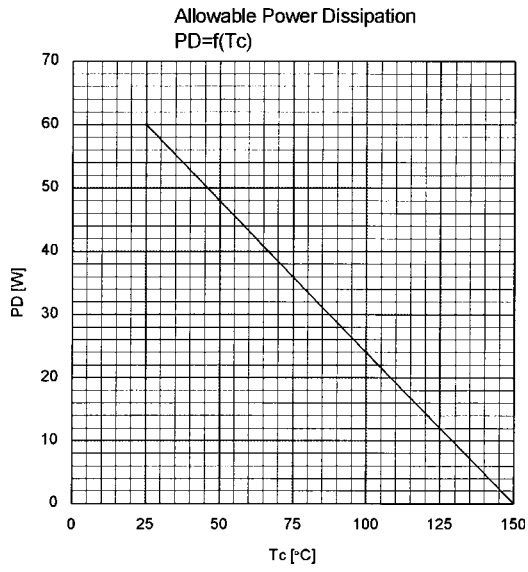

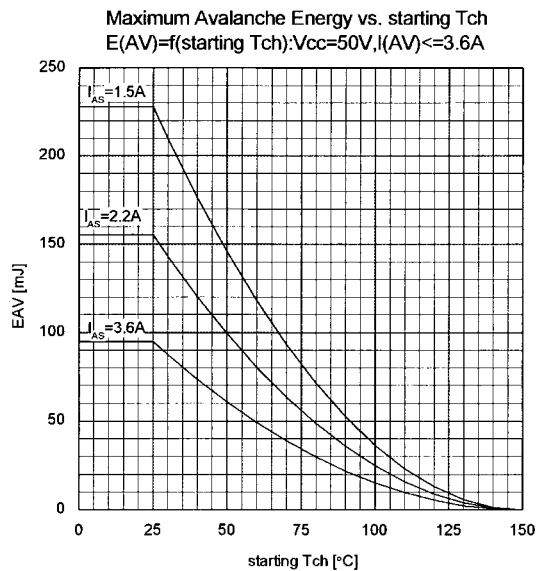
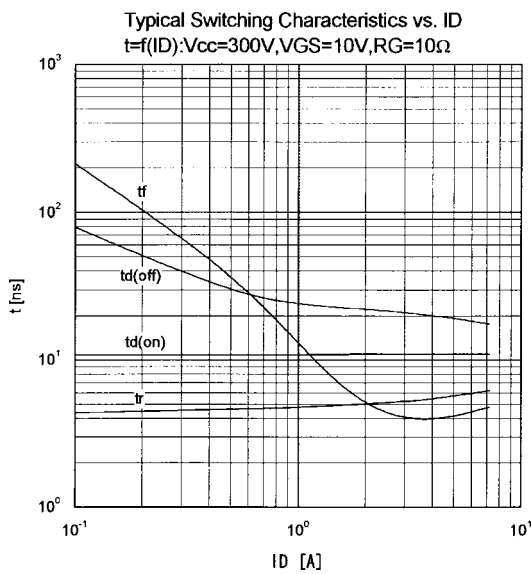
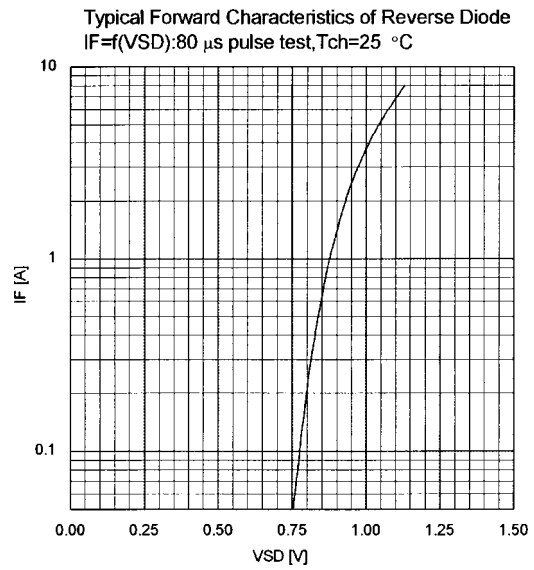
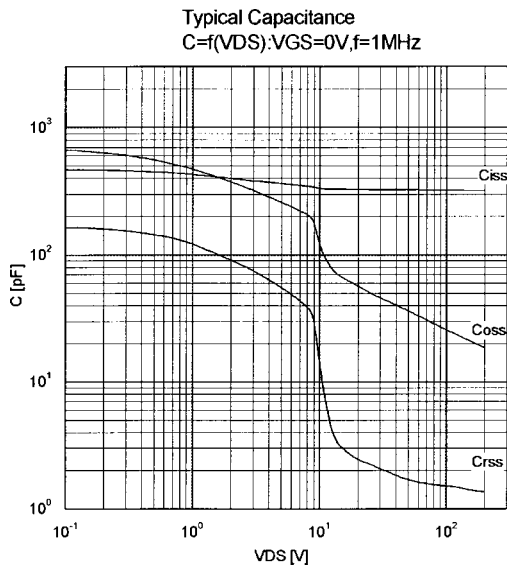
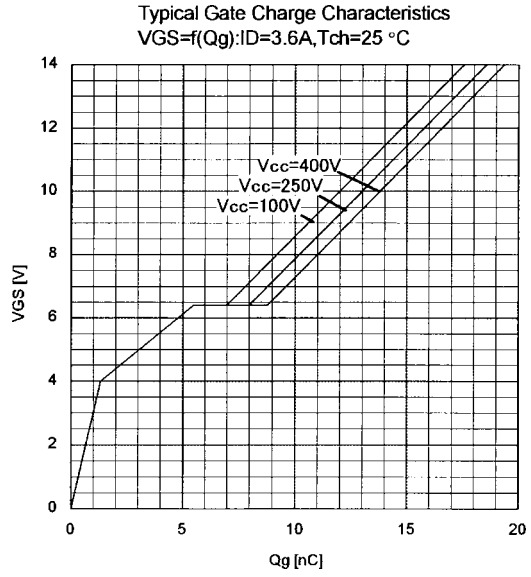
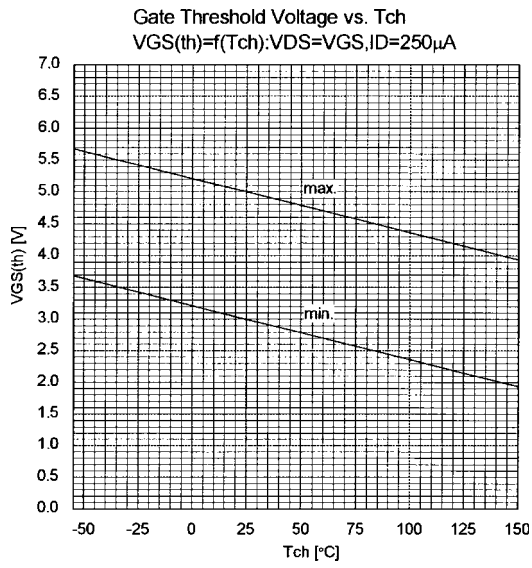

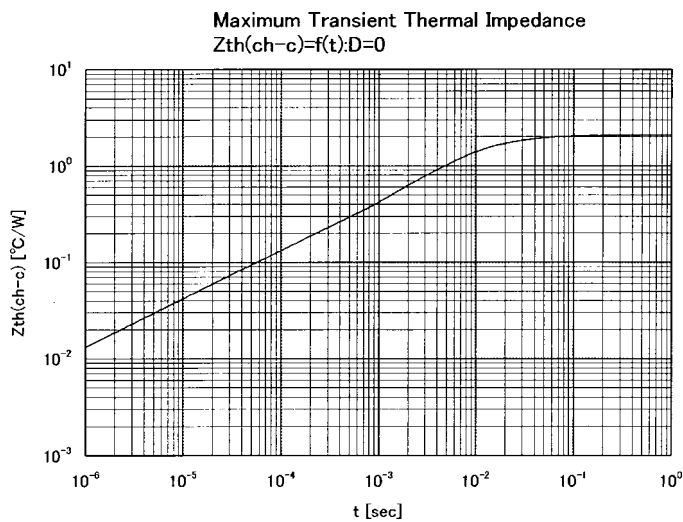
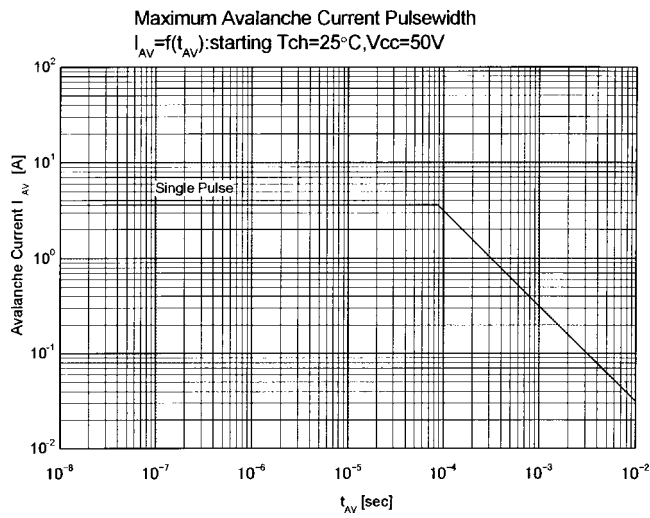

Outline Drawings [mm]

T-pack(L)

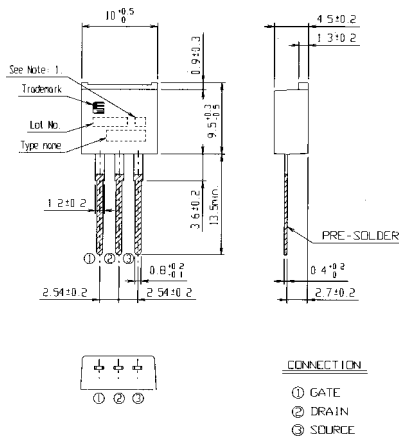

Note: 1 Guaranteed mark of avalanche ruggedness.

T-pack(S)

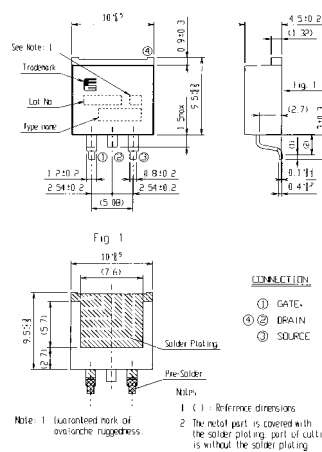

T-pack(SJ) [D2-pack]

